

## STANDARD PILLAR CAPS

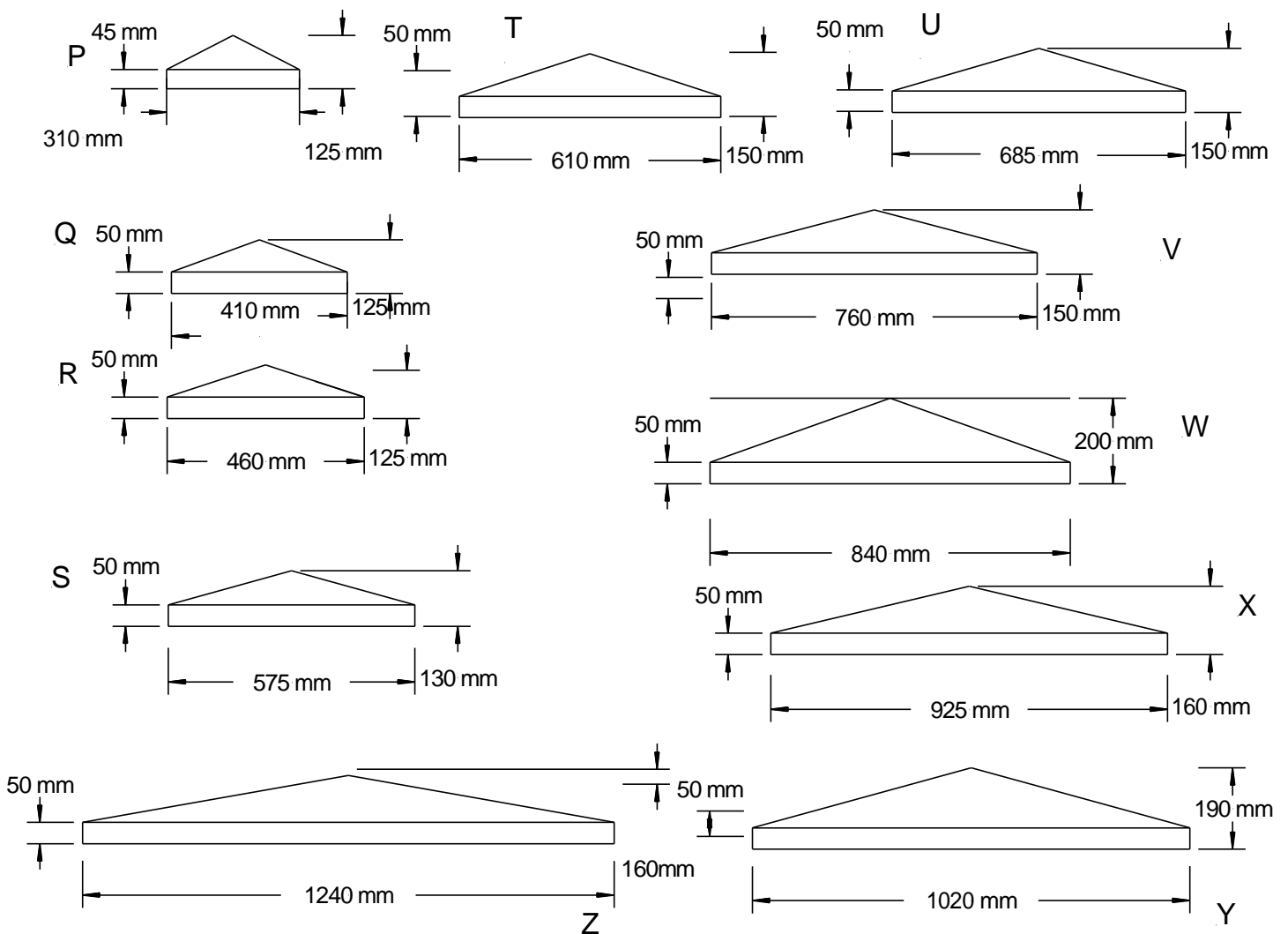

**DEEP PILLAR CAPS**

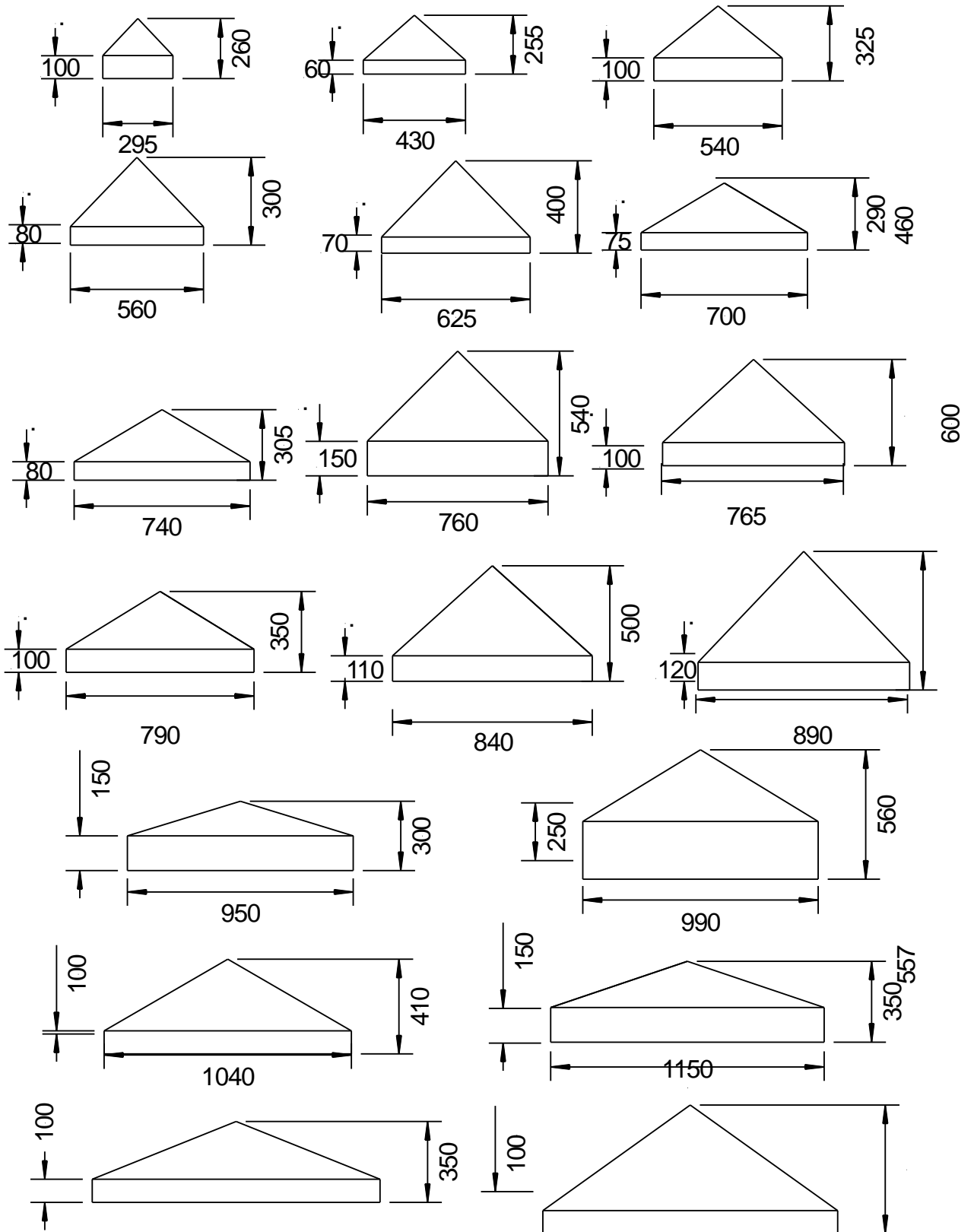

**CIRCULAR PILLAR CAPS**

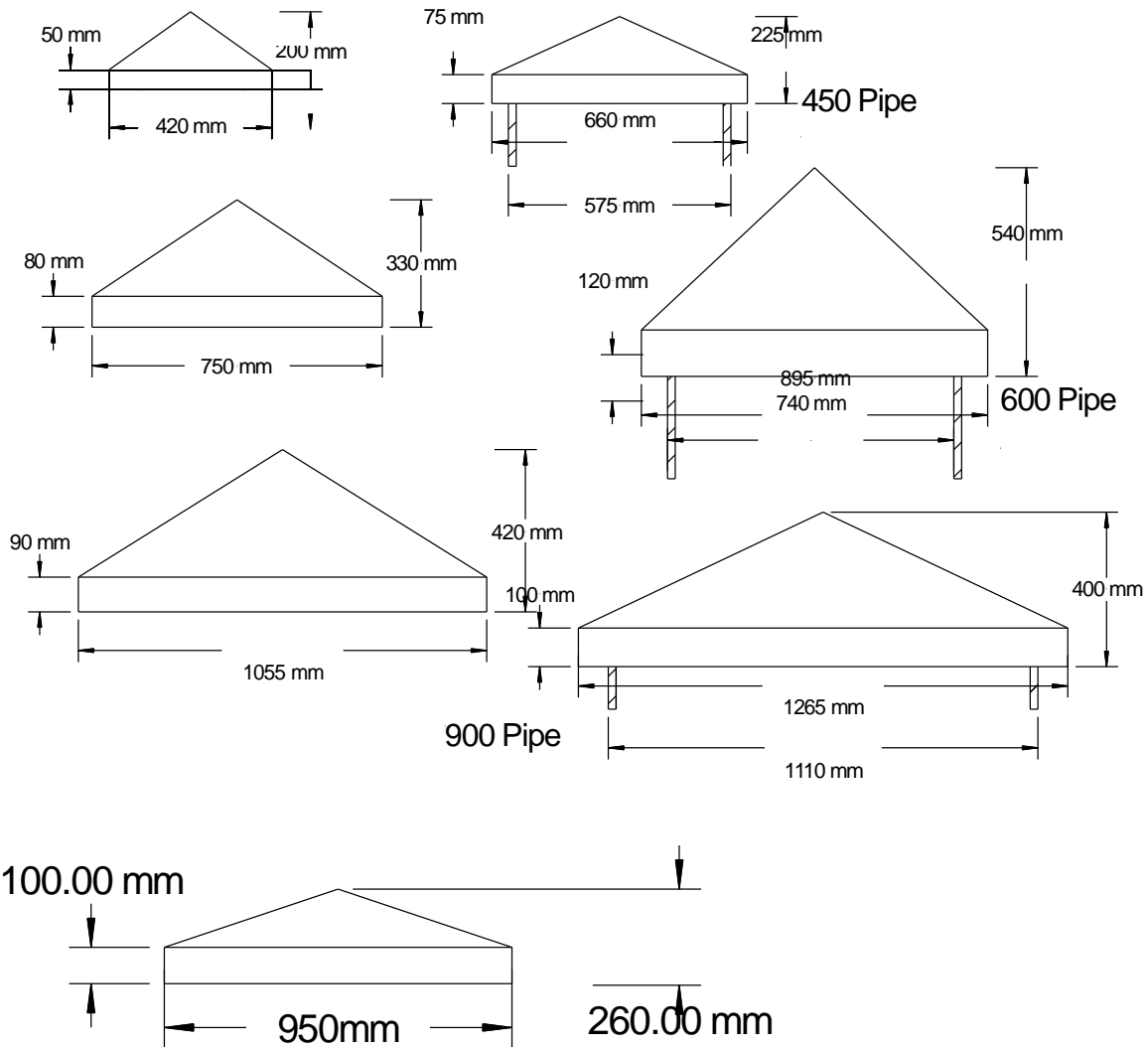

## FLAT TOP ORNAMENTAL PILLAR CAPS

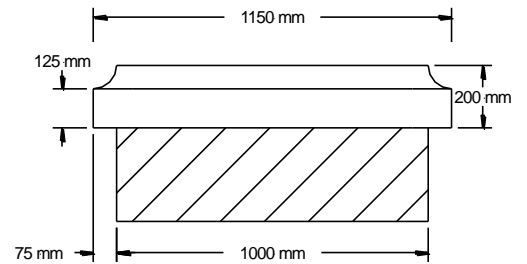
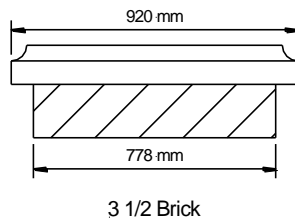
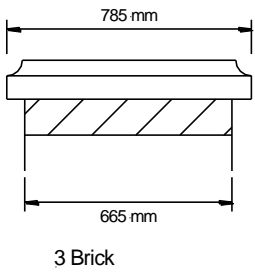
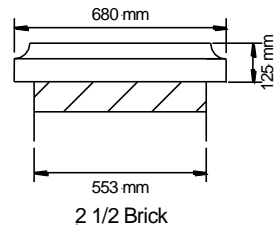
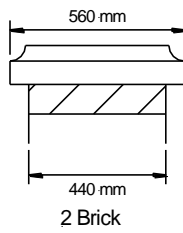
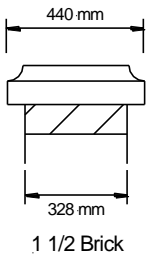

## ORNAMENTAL TYPE PILLAR CAP AND BASES

